

PART NO.	A24200-016	REV	ECO	DATE	APP
		A	106430	05-18-2020	TLM

MATERIAL AND FINISHES

INSULATOR:

THERMOPLASTIC PER MIL-M-24519, TYPE GLCP-30F OR TYPE GST-40F

CONTACT MATERIAL:

BERYLLIUM COPPER PER ASTM B194, ALLOY C17200

CONTACT FINISH:

GOLD PLATE PER ASTM B488, TYPE II (HARD GOLD), CODE C, CLASS 1.27 (.000050)

WIRE:

NEMA HP3 TYPE E, COLOR CODED IAW MIL-STD-681, SYSTEM 1, USING 10 SOLID REPEATING COLORS

LATCH:

BERYLLIUM COPPER PER ASTM B194

LATCH FINISH:

NICKEL PLATE (100 MICROINCHES MINIMUM) PER SAE-AMS-2404

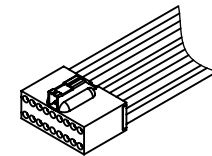
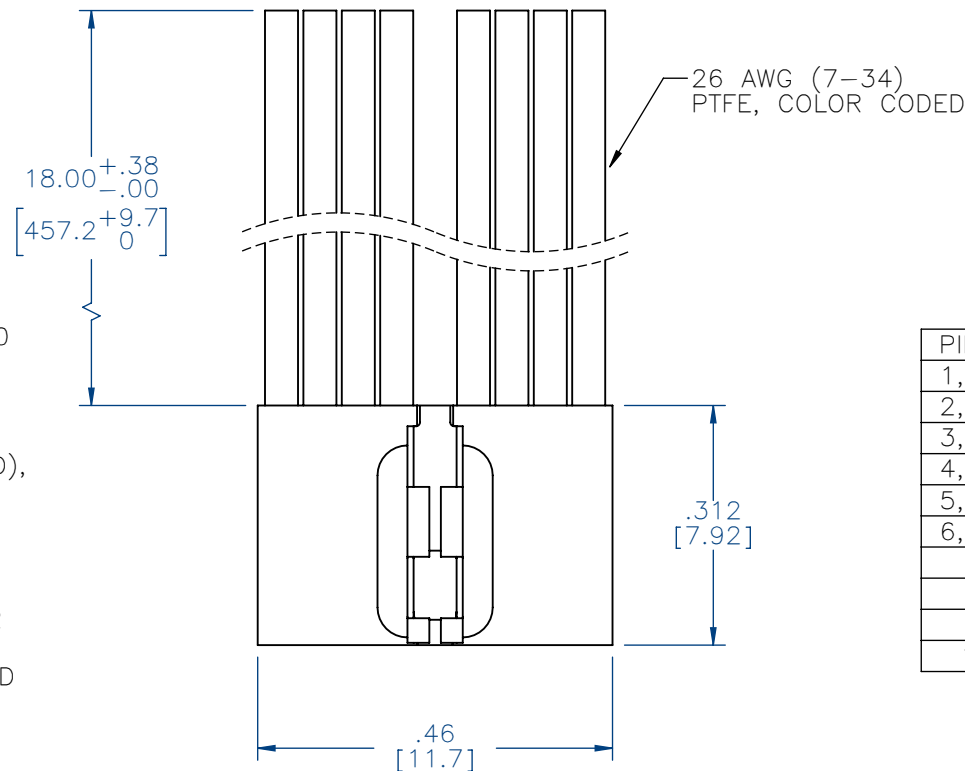

ACTUAL SIZE EXCLUDING WIRE LENGTH

PIN #	COLOR
1, 11	BLACK
2, 12	BROWN
3, 13	RED
4, 14	ORANGE
5, 15	YELLOW
6, 16	GREEN
7	BLUE
8	VIOLET
9	GRAY
10	WHITE

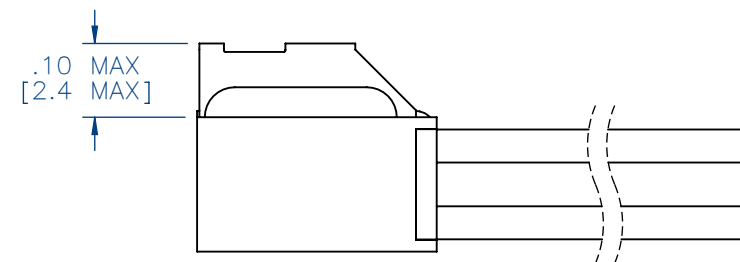
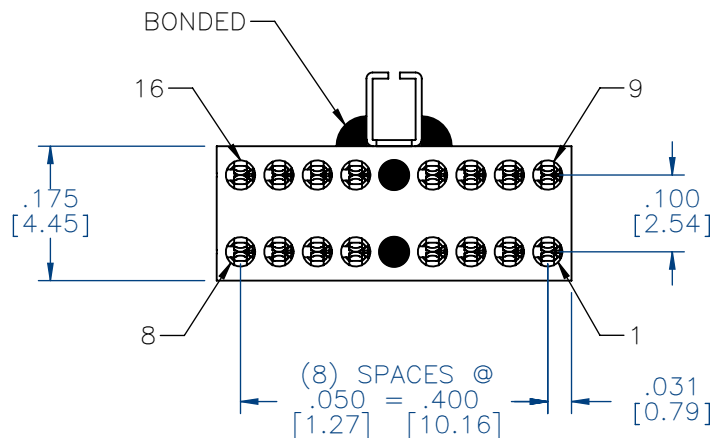

NOTE:

DIMENSIONS IN [] ARE IN MILLIMETERS UNLESS OTHERWISE NOTED AND ARE FOR REFERENCE ONLY

DRP	THIRD ANGLE
	-TOLERANCES-
	UNLESS OTHERWISE NOTED
	DIMENSIONS IN INCHES
SLDW	2 PL DEC ± .01
	3 PL DEC ± .005
	4 PL DEC ± .0005
	ANGLES ± 1°

THIS DRAWING CONTAINS CONFIDENTIAL AND PROPRIETARY INFORMATION WHICH IS THE PROPERTY OF OMNETICS CONNECTOR CORP. THIS DOCUMENT MAY NOT, IN WHOLE OR IN PART, BE DUPLICATED, OR DISCLOSED FOR ANY PURPOSE, WITHOUT WRITTEN PERMISSION FROM OMNETICS CONNECTOR CORP.	
DFTM. TLM	DATE 05-13-20
CHK'D.	DATE
APP'D.	DATE

TITLE:
**(16) PIN MALE
DUAL ROW CONNECTOR
W/LATCH**

OMNETICS
CONNECTOR CORPORATION
7260 COMMERCE CIRCLE EAST
MINNEAPOLIS, MN 55432
WWW.OMNETICS.COM

CAGE CODE 61873
DWG NO. A24200-016
SHEET 1 OF 2
SCALE: 4:1
REV A



PART NO.	A24200-016	REV	ECO	DATE	APP
		A	106430	05-18-2020	TLM

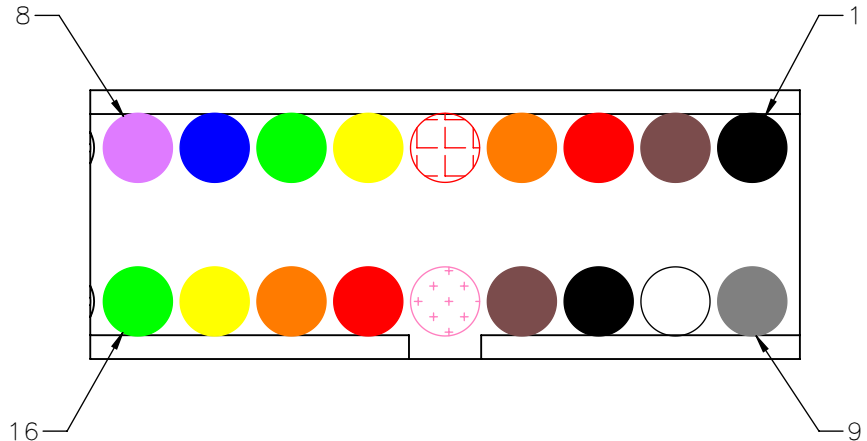

PIN #	COLOR
1, 11	BLACK
2, 12	BROWN
3, 13	RED
4, 14	ORANGE
5, 15	YELLOW
6, 16	GREEN
7	BLUE
8	VIOLET
9	GRAY
10	WHITE

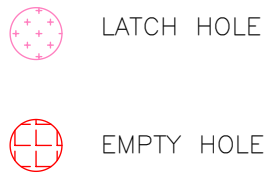

DRP	THIRD ANGLE 	THIS DRAWING CONTAINS CONFIDENTIAL AND PROPRIETARY INFORMATION WHICH IS THE PROPERTY OF OMNETICS CONNECTOR CORP. THIS DOCUMENT MAY NOT, IN WHOLE OR IN PART, BE DUPLICATED, OR DISCLOSED FOR ANY PURPOSE, WITHOUT WRITTEN PERMISSION FROM OMNETICS CONNECTOR CORP.	OMNETICS CONNECTOR CORPORATION 7260 COMMERCE CIRCLE EAST MINNEAPOLIS, MN 55432 WWW.OMNETICS.COM	CAGE CODE 61873	
	-TOLERANCES- UNLESS OTHERWISE NOTED			DWG NO. A24200-016	
SLDW	DIMENSIONS IN INCHES	DFTM. TLM	DATE 05-13-20	TITLE:	SHEET 2 OF 2
	2 PL DEC ± .01	CHK'D.	DATE	(16) PIN MALE	REV A
	3 PL DEC ± .005	APP'D.	DATE	DUAL ROW CONNECTOR W/LATCH	SCALE: 1:1
	4 PL DEC ± .0005				
	ANGLES ± 1°				